

PRODUCT DATASHEET

Focus the light to highlight the point , Led spot light
HYD-308-7W 4000K



Application

- Home
 - Restaurant
 - Exhibition Hall
 - Stage
 - Conference Room
 - Clothing Store
-

Benefits

- Flicker free
 - It can be used for emphasis lighting and decorative lighting
 - Spot light have prominent advantages in commercial lighting
 - No secondary light spot, it can create a wall washing effect
-

Features

- Warranty 5 years
 - Good light transmission
 - Small size, light weight, buckle design, easy to install
 - Die-cast aluminum, good heat dissipation, reduce light decay
-

Electrical Data

Nominal wattage (W)	7W
Nominal Voltage (V)	220-240 V
Mains Frequency (Hz)	50
Nominal Current (mA)	60
LED Driver Current (mA)	300
LED Driver Voltage (VDC)	15-24
LED Driver Efficiency (%)	80%
Power Factor λ	0.55
Total harmonic distortion (%)	...
Operating mode	External LED driver

Photometrical data

Luminous flux $\pm 10\%$ (lm)	715 lm
Luminous efficacy	98 lm/w
Color temperature	4000K
Light color (designation)	Natural White
Color rendering index Ra	≥ 80
Standard deviation of color matching	≤ 5 SDCM
Luminous intensity/cd	1591
Flickering	Flicker free
Beam angle	33 °

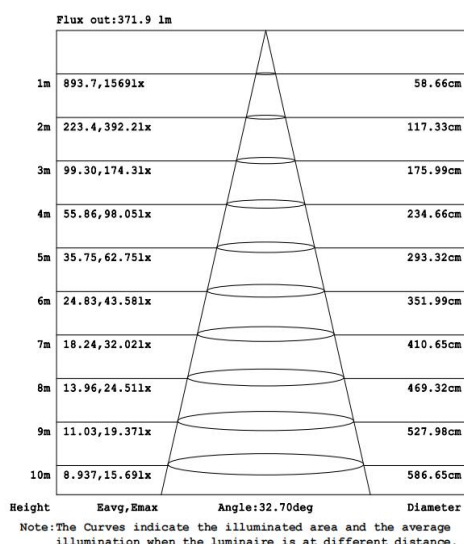
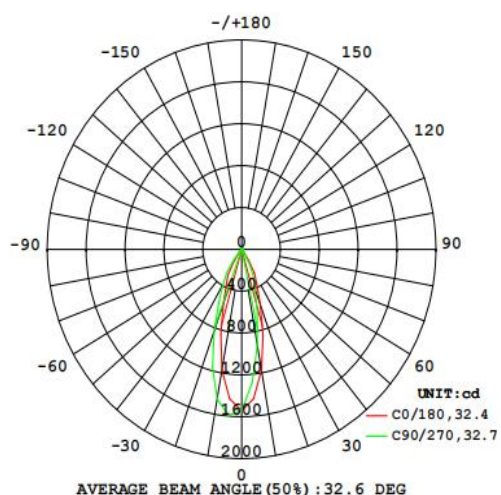

4000K

Dimensions & Weight

Diameter (mm)	90
Height (mm)	55
Product weight (g)	158

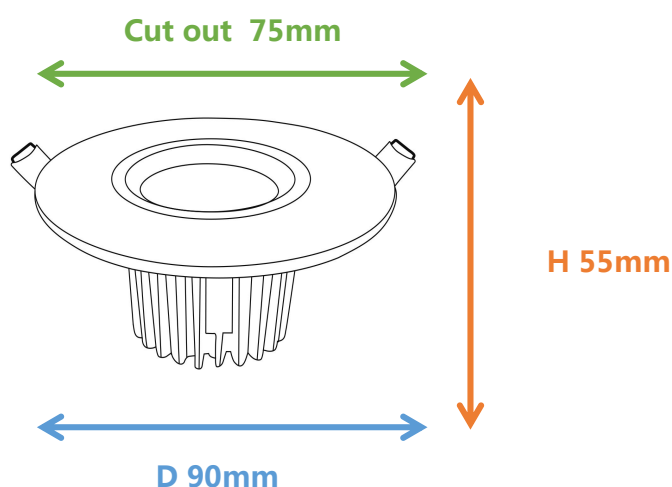

Material & Colors

Product color	White frame and Black housing
Housing color	Black
Body material	Aluminum
Cover material	PS diffuser material
Mercury content	0.0 mg

Application & Mounting

Ambient temperature range	-20°C~+45 °C
Temperature range at storage	-25°C~+60 °C
Type of connection	Screwless terminal
Type of protection	IP20
Dimmable	No
Mounting type	Recessed
Mounting location	Ceiling
Application environment	Indoor
Cut size (mm)	75
LED module replaceable	Not replaceable
With light source	Yes

Certificates & Lifespan

Life (h)	50,000
Certificates	CB CE LVD EMC
Standards	ISO9001:2015

Logistical Data

Product code	Dimensions (L*W*H)	Pcs/ carton	G.W. kg	Volume CBM
HYD-308-7W	54.5*37*44.5 cm	100	...	0.08973

Installation Method

Installation

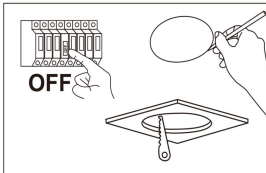

OFF

1. Turn off the power
2. Cut out a hole in the ceiling using the template hole diameter

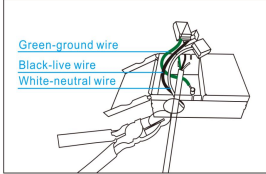

Green-ground wire
Black-live wire
White-neutral wire

3. Remove the appropriate knockout(s).
4. Put electrical wire from the power source through the mounting hole.

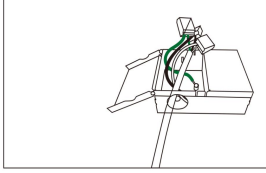

5. Connect the supply wires to the junction box wires using the easy push-in wire connectors.
 - Black to Black
 - White to white
 - Green to green

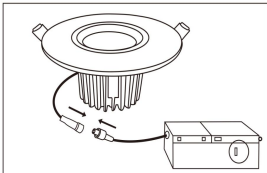

6. Connect the slim panel light to the junction box.

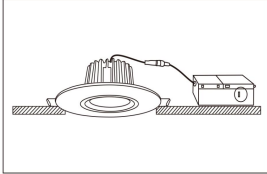

7. Push up the spring clips to install the light on to the ceiling.

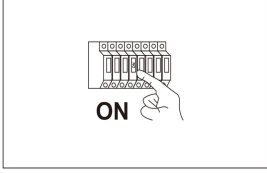

ON

8. Turn on the power after installation

Disclaimer

Subject to change without notice. Errors and omission excepted. Always make sure to use the most recent release.